

本公司智慧财产未经许可不得复制
ming biao copy/right may not be used without permission from ming biao.

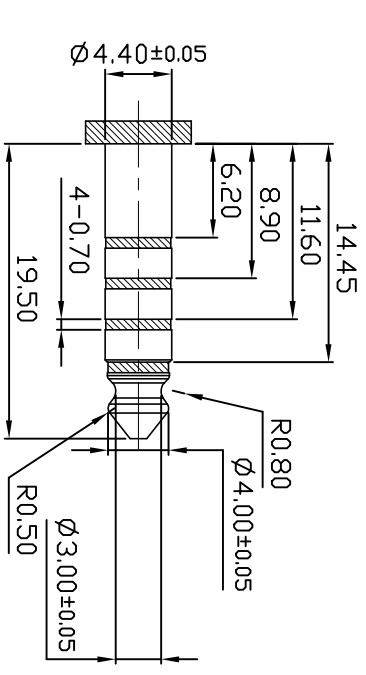

(ø4.40mm 5 POLE PLUG DETAIL DRAWING)

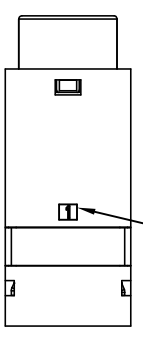
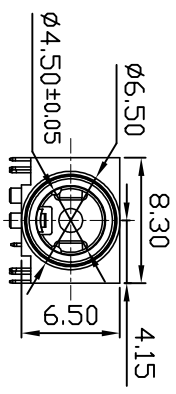

3D VIEW

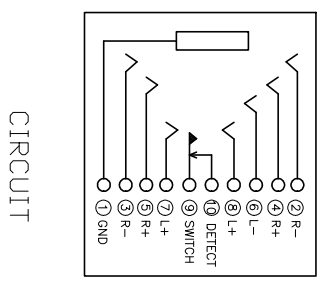
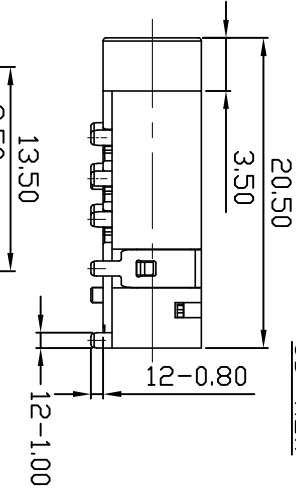
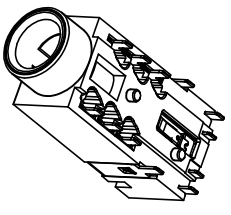

CIRCUIT

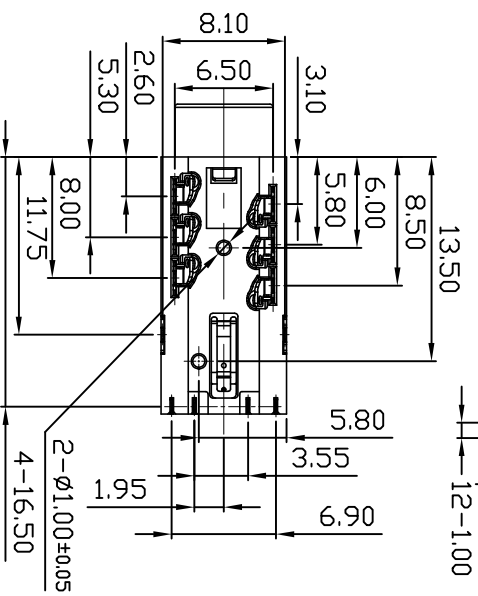
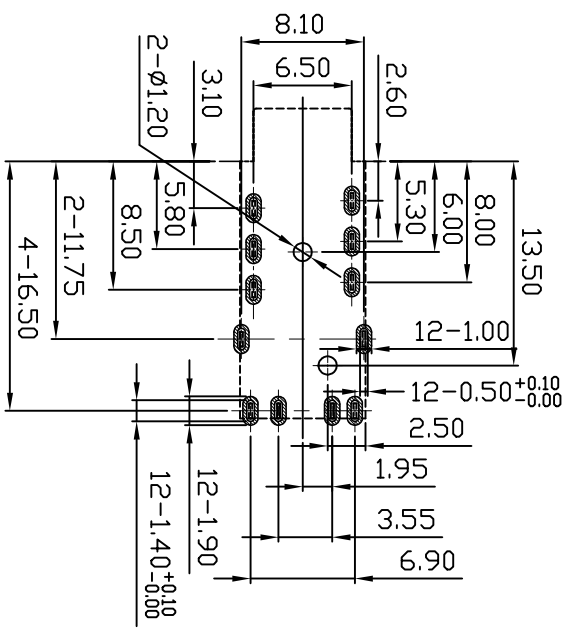

- 技术要求:
- 电气及机械焊性要求如下:
 - 接触阻抗: 50mΩ以下;
 - 绝缘阻抗: 100MΩ以上;
 - 耐电压: 500V AC以上;
 - 耐插拔: 5,000次以上;
 - 插入力: 0.5~2.5kgf (5~25N);
 - 拔出力: 0.5~2.5kgf (5~25N);
 - 除特别说明外, 无标示的尺寸均为参考尺寸;
 - 产品符合RoHS环保标准要求.

RECOMMENDED PCB LAYOUT
TOP VIEW TOL:±0.05



TOLERANCE UNLESS OTHERWISE STATED		DESIGN WYJ	
X.X	±0.20	SIZE	A4
X.XX	±0.15	REV	A
X.XXX	±0.10	UNIT	mm
	±2°	SCALE	2:1
DATE 2024.09.23		DATE 2024.09.23	
TITLE PHONE JACK		MODEL ST-332-T(DIP)	
SHEET 1/3		PRINT DATE 2025.07.07	

东莞市铭标电子科技有限公司
Ming Biao Electronic Technology Co., Ltd.