

本公司智慧财产未经许可不得复制
ming biao copyright, may not be used without permission from ming biao.

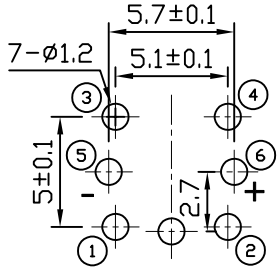

P.C.B LAYOUT

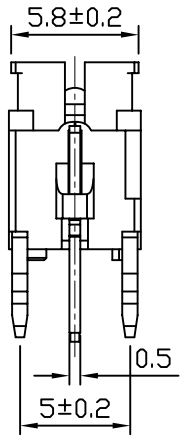
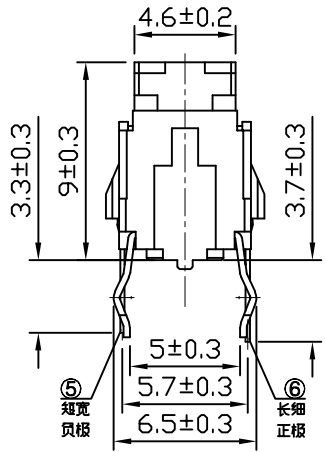
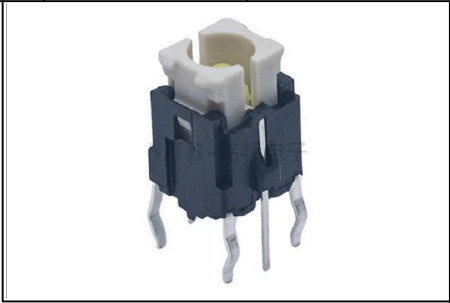
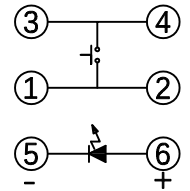

CIRCUIT

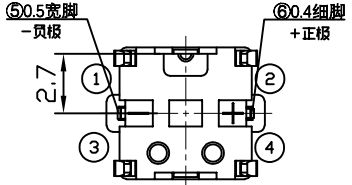
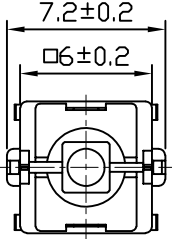

SPECIFICATIONS:
 Operating temperature range: -25°C to +75°C
 Rating: 30V DC, 30mA
 Insulation resistance: 100MΩ min. 100V DC
 Dielectric strength: 250V. AC. 1Min
 Contact resistance: 50mΩ Max
 Life: 100,000 Cycles
 Travel: 0.25±0.1mm
 Operating force: 160±50gf



灯光	灯光代码
白光	W White
红光	R Red
绿光	G Green
黄光	Y Yellow
蓝光	BL Blue
..

		东莞市铭标电子科技有限公司 Ming Biao Electronic Technology Co., Ltd.				
TOLERANCE UNLESS OTHERWISE STATED				DESIGN WYJ	DATE 2024.06.21	TITLE Illuminated Switch
X.X	±0.20	SIZE	A4	CHKD	DATE	MODEL LSP635-090J-R
X.XX	±0.15	REV	A	APPD	DATE	SHEET 1/3
X.XXX	±0.10	UNIT	mm	PRINT DATE 2024.07.05		
<	±2°	SCALE	3:1			