

REV.	ECN. NO.	APPD.

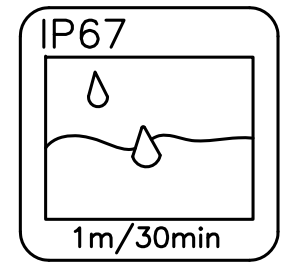

- NOTES:  
SPECIFICATION:
1. CURRENT RATING: 3.0A MAX
  2. DIELECTRIC WITHSTAND VOLTAGE: 100VAC
  3. TEMPERATURE RANGE: -30 °C ~ 85 °C
  4. CONTACT RESISTANCE: 40 MILLIONHM MAX
  5. INSULATION RESISTANCE: 100 MEGOHMS MIN.
  6. INSERTION FORCE : 5N~20N
  7. UNMATING FORCE: 8N~20N
  8. DURABILITY:10,000 CYCLES

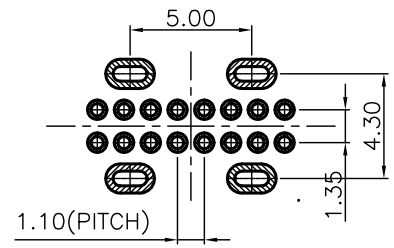
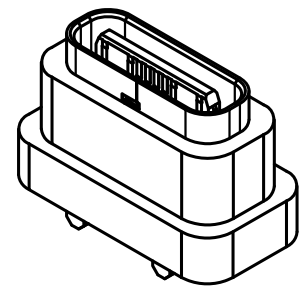
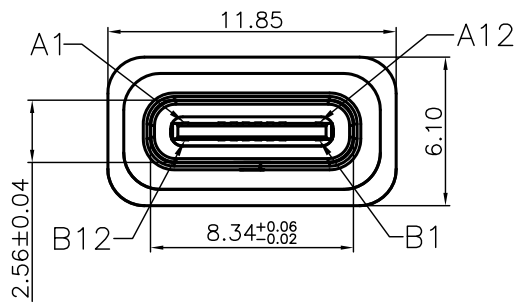

RECOMMENDED PCB LAYOUT(TOP VIEW)  
(GENERAL TOLERANCE±0.05)

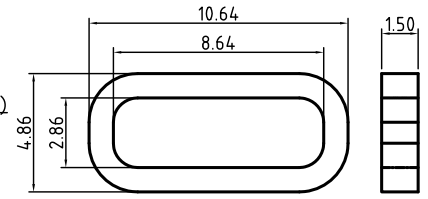

建议胶圈尺寸

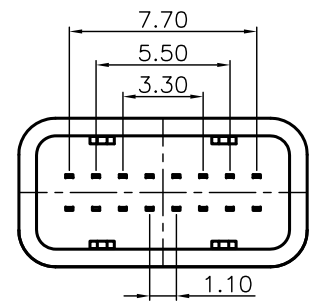
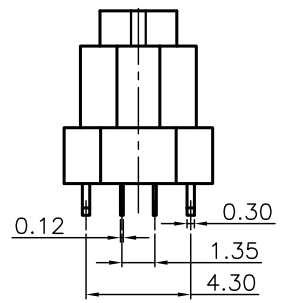
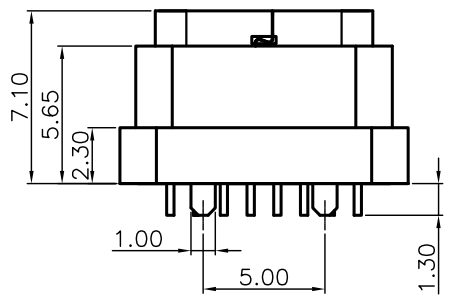

结构设计注意:  
1. 成品使用时, 如有洗面奶泡沫、牙膏、洗手液、脏污液体, 请在TYPE-C口外面再设计一层外壳, 保护TYPE-C表面金手指不会被脏污覆盖。

6	防水圈	硅胶	BLACK	1PCS
5	SHELL	STAINLESS STEEL	NI P- <del>XXXXXX</del>	1PCS
4	SHIELDING PLATE	STAINLESS STEEL	NI P- <del>XXXXXX</del>	1PCS
3	CONTACT	COPPER ALLOY	AO/NI P- <del>XXXXXX</del>	1SET
2	SHELL HOUSING	HIGH TEMPERATURE PLASTIC	BLACK	1PCS
1	HOUSING	HIGH TEMPERATURE PLASTIC	BLACK	1PCS
NO.	DESCRIPTION	MATERIAL	REMARKS	QTY

A1	GND	B12	GND
A4	VBUS	B9	VBUS
A5	CC1	B8	SBUE
A6	DP1	B7	DN2
A7	DN1	B6	DP2
A8	SBU1	B5	CC2
A9	VBUS	B4	VBUS
A12	GND	B1	GND
PIN	SIGNAL NAME	PIN	SIGNAL NAME

X.	±0.50	X.°	± 2°
.X	±0.30	.X°	± 1°
.XX	±0.10	.XX°	± 0.5°
XXX	±0.05		

UNITS: mm

MAT'L: /

FINISH: /

Q'TY: /

东莞市铭标电子科技有限公司

PART NO. **USBC-0052IPX7-00**

TITLE: 直立式防水TYPE C 16Pin

APPD: RADOM

CHKD: MARK

DR: JANE CHOU 2021/12/28

DWG NO.: **USBC-0052IPX7-00**

SCALE	SHEET	REV.
1/1	1/1	A1

Autodesk 教育版产品制作

Autodesk 教育版产品制作