

版本	变更日期	变更内容	责任人	备注
B	2022.05.17	增加产品材质电镀和模穴数说明	Liuzheng	

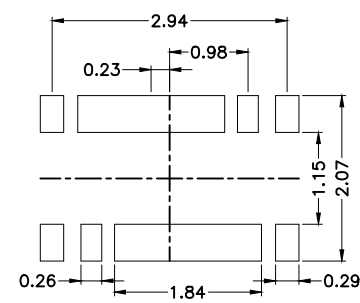

进胶点，不许高出胶芯面

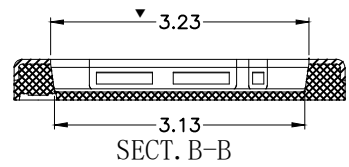
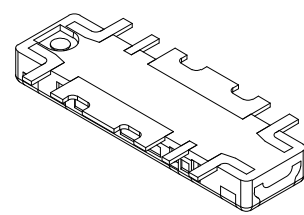
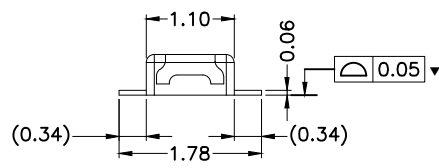
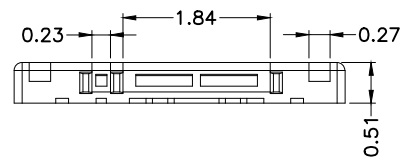
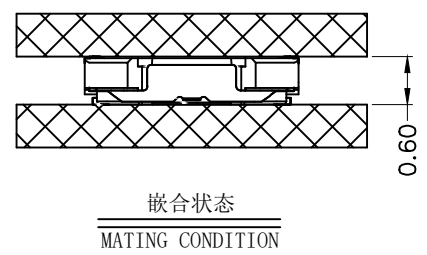
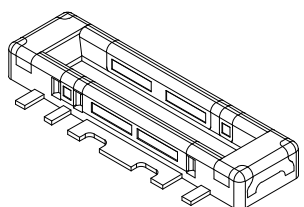
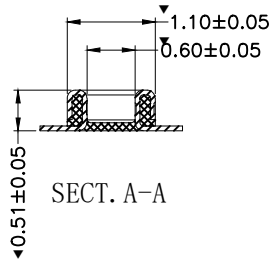
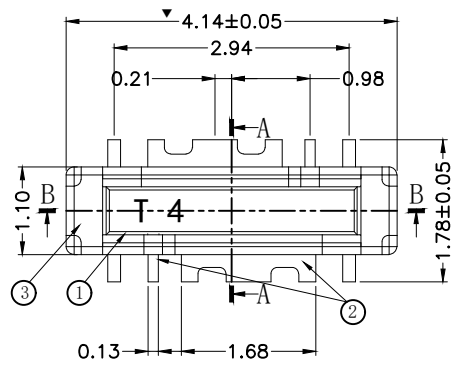
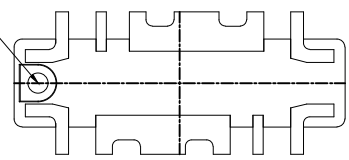

MIB-010M004-XX

SERIAL NUMBER: M: PLUG, F: SOCKET
未注: 全金, G: 隔镍
NUMBER OF CONTACTS

Recommended PCB layout

- 备注:
1. 塑胶材质: LCP UL 94V-0 BLACK;
 2. 端子材质: C7025 T=0.06mm
 3. 固定片材质: C5191 T=0.06mm
 4. 模穴号 (4A~4X), 24穴/模;
 5. ▼符号为QIP管控尺寸;
 6. 电镀:
端子, 镀金5u"MIN. 镍底50u" MIN.
固定片, 镀金5u"MIN. 镍底50u" MIN.

3	HOLD DOWN	2	C5191	GOLD (5u" MIN.), NICKEL 50u" MIN. OVER ALL	CONTACT AREA : GOLD (5u" MIN)
2	POWER CONTACT	4	C7025	GOLD (5u" MIN.), NICKEL 50u" MIN. OVER ALL	CONTACT AREA : GOLD (5u" MIN)
1	INSULATOR	1	LCP	--	--
NO.	DESCRIPTION	QTY.	MATERIAL	FINISH	REMARKS

X,±	X°,±	UNITS mm	NAME<INTENDED USE>	东莞市铭标电子科技有限公司
.X± 0.05	.X°± 1°	MAT'L	PART NO.<INTENDED USE>	
.XX± 0.02	.XX°± 0.5°	N/A	APPD:	TITLE: I/M
.XXX± 0.015	.XXX°±	FINISH	Q'TY	DWG NO.: MIB-010M004
THE GENERATED DRAWING IS BY ACAD, PROE OR IDEAS.DO NOT CHANGE BY HAND.			CHKD:	
			DR:	